

Printer Warning:

This packet is lengthy. Determine whether you want to print both sections, or only print Section 1 or 2.





Grade 3 Reading

Student Activity Packet 1

Flip to see the Grade 3
Reading activities
included in this packet!

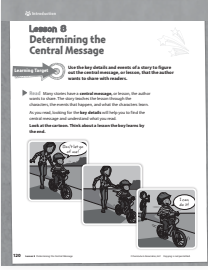

Grade 3 Reading Activities in Section 1

Lesson	Resource	Instructions	Page(s)
1	<p>Grade 3 Ready Reading Lesson 8 Determining the Central Message Part 1</p> 	<ul style="list-style-type: none"> • Read the Introduction. • Complete the Think chart. • Complete the Talk activity. 	10–11
2	<p>Grade 3 Ready Reading Lesson 8 Part 2</p> 	<ul style="list-style-type: none"> • Read “The Girl and the Apples.” • Complete the Think chart and the Talk activity. • Complete the Write activity. 	12–14

Grade 3 Reading Activities in Section 1 (Cont.)

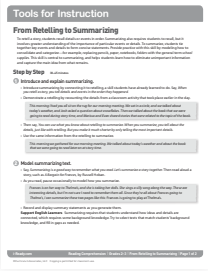
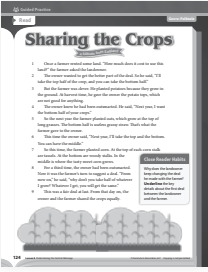
Lesson	Resource	Instructions	Page(s)
3	<p>Tools for Instruction From Retelling to Summarizing</p> 	<ul style="list-style-type: none"> • Parent/Guardian: Read the instructions and guide the student through the exercise. When the activity requires a text, choose the text the student read in the previous lesson. 	15–16
4	<p>Grade 3 Ready Reading Lesson 8 Part 3</p> 	<ul style="list-style-type: none"> • Read “Sharing the Crops.” • Complete the Think and Talk activities. • Complete the Write activity. 	17–19

Section 1 Table of Contents

Grade 3 Reading Activities in Section 1 (Cont.)

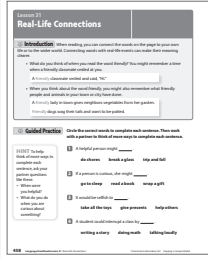
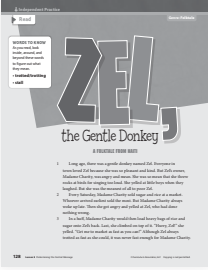
Lesson	Resource	Instructions	Page(s)
5	<p>Grade 3 Ready Language Handbook Lesson 31 Real-Life Connections</p> 	<ul style="list-style-type: none"> • Read the Introduction. • Complete the Guided Practice. • Complete the Independent Practice. 	20–21
6	<p>Grade 3 Ready Reading Lesson 8 Part 4</p> 	<ul style="list-style-type: none"> • Read “Zel, the Gentle Donkey.” • Complete the Think activity. 	22–26

Grade 3 Reading Activities in Section 1 (Cont.)

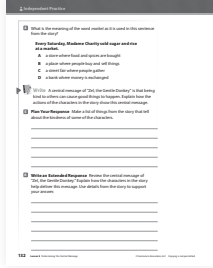
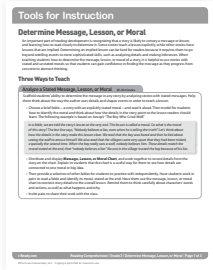

Lesson	Resource	Instructions	Page(s)
7	<p>Grade 3 Ready Reading Lesson 8 Part 5</p> 	<ul style="list-style-type: none"> • Reread “Zel, the Gentle Donkey.” • Complete the Write activities. 	26–27
8	<p>Tools for Instruction Determine Lesson, Message, or Moral</p> 	<ul style="list-style-type: none"> • Parent/Guardian: Read the instructions and guide the student through the activity. Use this with a text the student read in a previous lesson. 	28–30

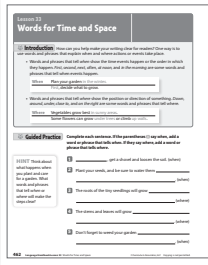
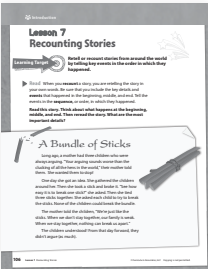
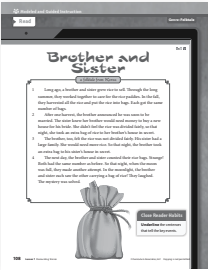
Grade 3 Reading Activities in Section 2

Lesson	Resource	Instructions	Page(s)
1	<p>Grade 3 Ready Language Handbook Lesson 33</p> 	<ul style="list-style-type: none"> • Read the Introduction. • Complete Guided Practice and Independent Practice. 	31–32
2	<p>Grade 3 Ready Reading Lesson 7 Part 1</p> 	<ul style="list-style-type: none"> • Read the Introduction. • Complete the Think and Talk activities. 	33–34
3	<p>Grade 3 Ready Reading Lesson 7 Part 2</p> 	<ul style="list-style-type: none"> • Read “Brother and Sister.” • Complete Think, Talk, and Write activities. 	35–37

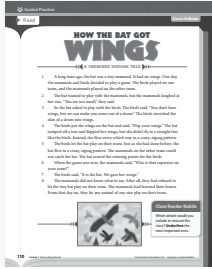

Section 2 Table of Contents

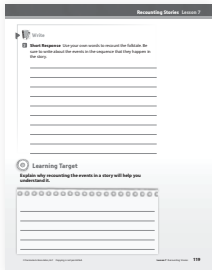
Grade 3 Reading Activities in Section 2 (Cont.)

Lesson	Resource	Instructions	Page(s)
4	<p>Grade 3 Ready Reading Lesson 7 Part 3</p> 	<ul style="list-style-type: none"> • Read “How the Bat Got Wings.” • Complete Think, Talk, and Write activities. 	38–40
5	<p>Grade 3 Ready Reading Lesson 7 Part 4</p> 	<ul style="list-style-type: none"> • Read “True and False.” • Complete the Think activity. 	41–45
6	<p>Grade 3 Ready Reading Lesson 7 Part 5</p> 	<ul style="list-style-type: none"> • Reread the passage “True and False.” • Complete the Write activity. 	46

Section 2 Table of Contents

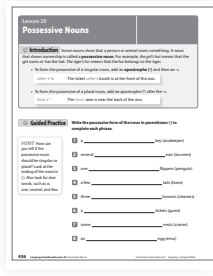
Grade 3 Reading Activities in Section 2 (Cont.)

Lesson	Resource	Instructions	Page(s)
7	<p>Practice Assessment</p> 	<ul style="list-style-type: none"> • Read "Following the Stars." • Answer items 1–5. 	47–51
8	<p>Grade 3 Ready Language Handbook Lesson 20 Possessive Nouns</p> 	<ul style="list-style-type: none"> • Read the Introduction. • Complete Guided Practice and Independent Practice. 	52–53
9	<p>Practice Assessment</p> 	<ul style="list-style-type: none"> • Read "Baby Bird." • Complete items 23–26. 	54–56

Independent Reading!

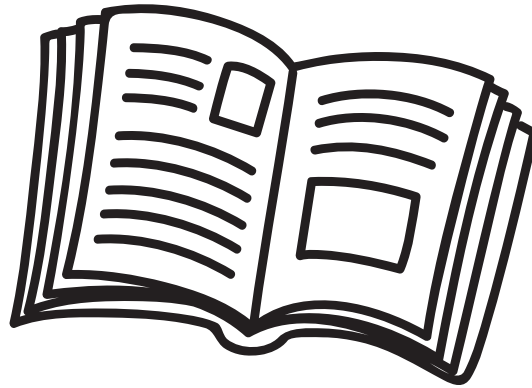

See pages
57 and 58
of this
packet.



Use the questions/ prompts on the Discourse Card resource to start a conversation about something the student has read. You may talk about a text the student read in one of the lessons above, or anything else the student is reading.

Encourage daily reading. And remember, reading isn't just about the books on the shelves—it's about anything around you with letters! Turn on the closed captioning feature on your TV or read catalogs that come in the mail. The backs of cereal boxes work, too, as do directions to board games!

Running out of stuff to read? **Grab some sticky notes, and label household objects, or make up new, silly names for things!** Communicating with sticky notes, instead of talking, is fun, too—start with a half hour and see if you can go all afternoon. Reading is everywhere!

Don't worry about right/wrong answers when you talk about text—the important thing is that you and your student share a reading experience and have fun!

Here are some websites that offer fun, free, high-quality material for kids:

www.starfall.com

www.storyplace.org

www.uniteforliteracy.com

www.storynory.com

www.freekidsbooks.org

en.childrenslibrary.org

Lesson 8

Determining the Central Message



Learning Target

Use the key details and events of a story to figure out the central message, or lesson, that the author wants to share with readers.

- **Read** Many stories have a **central message**, or lesson, the author wants to share. The story teaches the lesson through the characters, the events that happen, and what the characters learn.

As you read, looking for the **key details** will help you to find the central message and understand what you read.

Look at the cartoon. Think about a lesson the boy learns by the end.

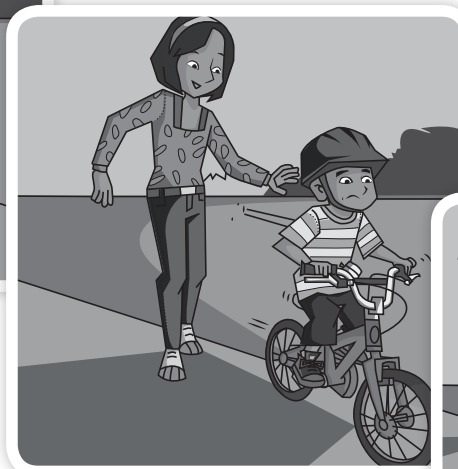

► **Think** The events in the cartoon tell about a problem the boy has and what he does. Complete the chart by adding the key details. Use those details to figure out the central message of the cartoon.

Key Detail	Key Detail	Key Detail
↓	↓	↓
What Is the Central Message?		

► **Talk** Using the key details in the chart, talk about the central message of the cartoon.

 **Academic Talk**
Use these phrases to talk about the text.

- **central message**
- **key details**

The Girl and the Apples

by Tala Rutchel

- 1 One fall afternoon, a girl went to a farm to pick apples. She was in a hurry, so she picked carelessly both ripe apples and unripe ones. When she finished, her wagon was filled with a small mountain of apples.
- 2 The girl asked the farmer, “Quick, tell me how long you think it will take me to get back home.”
- 3 The farmer thought carefully. Then he said, “Be patient. If you go slowly, you will be back soon. If you go fast, you will not get back until night. It’s your choice.”
- 4 The girl thought, “How can that be? How can it take so long if I go fast?”
- 5 The girl wanted to get back home as soon as possible, so she rushed her horse and wagon onto the road. She made her horse walk very fast.
- 6 And suddenly . . . bump! Off fell some apples.
- 7 Every time she hit a bump, more apples rolled off her wagon. Then she had to stop and put them back on the wagon. Because of all the delays, it was night before she got home.



Close Reader Habits

Underline key details that help you figure out the central message.

Explore

How can key details help you figure out what lesson the girl in the story learns?



To find the central message, think about what each key character says and does.

Think

- 1 Complete the chart by writing some key details about what the characters say and do. Then write the central message, or lesson.

Key Details (the Girl)

Key Details (the Farmer)

What Is the Central Message?

Talk

- 2 Think about the message of the story. Talk about what the girl learned.



Write

- 3 **Short Response** What is another lesson the girl might learn from what happened? Use the space provided on page 14 to write your answer.

HINT What might the girl think about the farmer's advice by the end of the story?

Tools for Instruction

From Retelling to Summarizing

To retell a story, students recall details or events in order. Summarizing also requires students to recall, but it involves greater understanding of the importance of particular events or details. To summarize, students tie together key events and details to form concise statements. Provide practice with this skill by modeling how to consolidate and categorize—for example, replacing *pencils, paper, notebooks, folders* with the general term *school supplies*. This skill is central to summarizing, and helps students learn how to eliminate unimportant information and capture the main idea from what remains.

Step by Step 30–45 minutes

1 Introduce and explain summarizing.

- Introduce summarizing by connecting it to retelling, a skill students have already learned to do. Say, *When you retell a story, you tell details and events in the order they happened.*
- Demonstrate a retelling by recounting the details from a classroom activity that took place earlier in the day.

This morning I had you all sit on the rug for our morning meeting. We sat in a circle, and we talked about today's weather, and Josh asked a question about snowflakes. Then we talked about the book that we were going to read during story time, and Marissa and Evan shared stories that were related to the topic of the book.

- Then say, *You can use what you know about retelling to summarize. When you summarize, you tell about the details, just like with retelling. But you make it much shorter by only telling the most important details.*
- Use the same information from the retelling to summarize.

This morning we gathered for our morning meeting. We talked about today's weather and about the book that we were going to read later on at story time.

2 Model summarizing text.

- Say, *Summarizing is a good way to remember what you read. Let's summarize a story together.* Then read aloud a story, such as *A Bargain for Frances*, by Russell Hoban.
- As you read, pause occasionally to model how you summarize.

Frances is on her way to Thelma's, and she is taking her dolls. She sings a silly song along the way. These are interesting details, but I'm not sure I need to remember them all. Since they're all about Frances going to Thelma's, I can summarize these two pages like this: Frances is going to play at Thelma's.

- Record and display summary statements as you generate them.

Support English Learners Summarizing requires that students understand how ideas and details are connected, which requires some background knowledge. Try to select texts that match students' background knowledge, and fill in gaps as needed.

3 Provide guided practice with summarizing text.

- Continue reading, and pause to engage students in summarizing with you. Focus attention on specific summarizing skills, such as combining related information.

Thelma offers to sell Frances her cups and saucers, sugar bowl, cream pitcher, and teapot. This is a long list to remember! When readers summarize, they think about how lists like this are related. Think about how these things Thelma is selling are alike. What is a name we can give them? (tea set) So how can we summarize this page? (Thelma offers to sell Frances her tea set.)

- Continue to record summary statements.
- When you have finished reading, read the summary statements in order for a summary of the entire story.

4 Provide repeated practice with summarizing text.

- Use additional read alouds to provide frequent practice with summarizing.
- Provide these question prompts to help students transfer summarizing to independent reading.

- What are the most important things about _____?
- What's interesting about _____ but not so important?
- Can you think of one word to describe _____, _____, and _____?
- What is a shorter way to tell what happened when _____?

Connect to Writing Have students divide a sheet of paper into as many boxes as chapters in the book, or into three sections for beginning, middle, and end. As they read independently or listen to read alouds, have students draw and/or write the most important ideas, one per box.

Check for Understanding

If you observe...	Then try...
difficulty distinguishing important ideas and details	using stories from the day to provide practice. Revisit a recent class activity. Provide two details, and have students think about which is more important. As the student demonstrates understanding, transfer the process to practicing with a story or poem.
difficulty determining how ideas or events in a story can be condensed	using relatable examples. You might say, <i>What's another way to tell what's happening when students tidy up their desks, put on their jackets, and line up by the door? (It's time to go home.)</i> Relate this to combining events in a story.

Sharing the Crops

a folktale from England

- 1 Once a farmer rented some land. “How much does it cost to use this land?” the farmer asked the landowner.
- 2 The owner wanted to get the better part of the deal. So he said, “I’ll take the top half of the crop, and you can take the bottom half.”
- 3 But the farmer was clever. He planted potatoes because they grow in the ground. At harvest time, he gave the owner the potato tops, which are not good for anything.
- 4 The owner knew he had been outsmarted. He said, “Next year, I want the bottom half of your crops.”
- 5 So the next year the farmer planted oats, which grow at the top of long grasses. The bottom half is useless grassy straw. That’s what the farmer gave to the owner.
- 6 This time the owner said, “Next year, I’ll take the top and the bottom. You can have the middle.”
- 7 So this time, the farmer planted corn. At the top of each corn stalk are tassels. At the bottom are woody stalks. In the middle is where the tasty sweet corn grows.
- 8 For a third time, the owner had been outsmarted. Now it was the farmer’s turn to suggest a deal. “From now on,” he said, “why don’t you take half of whatever I grow? Whatever I get, you will get the same.”
- 9 This was a fair deal at last. From that day on, the owner and the farmer shared the crops equally.

Close Reader Habits

Why does the landowner keep changing the deal he made with the farmer? **Underline** the key details about the first deal between the landowner and the farmer.





To find the central message of a story, think about which character learns a lesson.

Think

- 1 This question has two parts. Answer Part A. Then answer Part B.

Part A

What is the central message of “Sharing the Crops”?

- A It is wrong to try to cheat others.
- B Never make a deal with a clever farmer.
- C The best part of a crop is usually at the top.
- D If a plan doesn’t succeed, keep trying.

Part B

Which sentence from the story **best** supports the answer you chose for Part A above?

- A “Once a farmer rented some land.”
- B “The owner wanted to get the better part of the deal.”
- C “This was a fair deal at last.”
- D “So this time, the farmer planted corn.”

Talk

- 2 Using key details from the text, talk to your partner about how the farmer outsmarts the landowner.



Write

- 3 **Short Response** Explain which character in “Sharing the Crops” learns a lesson. Use one detail from the folktale to support your response. Use the space provided on page 19 to write your answer.

HINT Reread to look for the character who learns a lesson.

Lesson 31

Real-Life Connections

 **Introduction** When reading, you can connect the words on the page to your own life or to the wider world. Connecting words with real-life events can make their meaning clearer.

- What do you think of when you read the word *friendly*? You might remember a time when a friendly classmate smiled at you.

A friendly classmate smiled and said, "Hi."

- When you think about the word *friendly*, you might also remember what friendly people and animals in your town or city have done.

A friendly lady in town gives neighbors vegetables from her garden.

Friendly dogs wag their tails and want to be patted.

Guided Practice

Circle the correct words to complete each sentence. Then work with a partner to think of more ways to complete each sentence.

HINT To help think of more ways to complete each sentence, ask your partner questions like these.

- When were you helpful?
- What do you do when you are curious about something?

1 A helpful person might _____ .

do chores **break a glass** **trip and fall**

2 If a person is curious, she might _____ .

go to sleep **read a book** **wrap a gift**

3 It would be selfish to _____ .

take all the toys **give presents** **help others**

4 A student could interrupt a class by _____ .

writing a story **doing math** **talking loudly**

Independent Practice

For numbers 1–5, choose the correct answer to each question.

- 1** How might a **patient** person act?
 - A** tell a friend to hurry up
 - B** run to be first in line
 - C** refuse to wait for someone
 - D** teach a baby something new

- 2** What might a **stubborn** person say?
 - A** "I like this new food after all."
 - B** "I won't eat that even if it's good for me."
 - C** "I agree with you about that."
 - D** "I'll stay home because you need my help."

- 3** What might a **generous** person do?
 - A** help a friend with homework
 - B** eat candy without sharing
 - C** disobey his parents
 - D** scare a friend's dog

- 4** How might someone cause **confusion**?
 - A** by solving a problem
 - B** by telling the truth
 - C** by giving poor directions
 - D** by speaking clearly

- 5** What is a **rude** thing to do?
 - A** invite a friend to a party
 - B** talk while others are talking
 - C** offer to wash the dishes
 - D** help a neighbor plant a garden

WORDS TO KNOW

As you read, look inside, around, and beyond these words to figure out what they mean.

- trotted/trotting
- stall

ZEL

the Gentle Donkey

A FOLKTALE FROM HAITI

- 1 Long ago, there was a gentle donkey named Zel. Everyone in town loved Zel because she was so pleasant and kind. But Zel's owner, Madame Charity, was angry and mean. She was so mean that she threw rocks at birds for singing too loud. She yelled at little boys when they laughed. But she was the meanest of all to poor Zel.
- 2 Every Saturday, Madame Charity sold sugar and rice at a market. Whoever arrived earliest sold the most. But Madame Charity always woke up late. Then she got angry and yelled at Zel, who had done nothing wrong.
- 3 In a huff, Madame Charity would then load heavy bags of rice and sugar onto Zel's back. Last, she climbed on top of it. "Hurry, Zel!" she yelled. "Get me to market as fast as you can!" Although Zel always trotted as fast as she could, it was never fast enough for Madame Charity.



4 One day, Zel's friend Touloulou the crab visited. "Did you have a good day at the market?" asked Touloulou.

5 "Madame Charity was mad at me all day. I work as hard as I can, but she is always mean to me."

6 "Madame Charity is always late. She won't blame herself, so she blames you," said Touloulou.

7 "Yes," said Zel. "And because everyone is afraid of her angry tongue, she never sells much at the market."

8 "I will help you," said Touloulou.

9 The next Saturday, Madame Charity woke up at 9 a.m. "Oh, no! I'm late again!" she yelled. As she tossed her heavy bags onto Zel's back, Touloulou the crab grabbed onto the hem of her long skirt. Madame Charity climbed on Zel's back. Touloulou held tightly to her skirt.

10 Zel started trotting. Madame Charity remembered how late she was. She opened her mouth to speak angrily, but Touloulou pinched her ankle.

11 “Ouch!” Madame Charity rubbed her ankle. She forgot how late she was. But soon she remembered. “Faster, Zel! Faster!” she yelled.

12 Again Touloulou pinched Madame Charity’s ankle.

13 “Ouch!” shouted Madame Charity.

14 When they got to the market, Madame Charity saw that someone had taken the stall she liked to use. In a fit of rage, Madame Charity opened her mouth to yell. For the third time, Touloulou pinched her ankle. Madame Charity screamed.

15 “What’s wrong?” people asked.

16 “Hurrying to get to market, I must have hurt my ankle. It’s very painful. Ouch! Ouch! Ouch!”

17 The fish seller said, “Madame Charity, you should get up earlier. Then you will not have to rush. Next week, I will wake you at 6 a.m.”

18 “Thank you,” said Madame Charity. She was surprised at the man’s kindness.

19 “Let me fix your ankle,” said the fruit seller. In the past, the fruit seller had not talked to Madame Charity. Today he felt sorry for her.

20 When Madame Charity saw how kind everyone was, she smiled. For the first time, she sold all of her rice and sugar. At the end of the day, she saddled Zel gently and rode quietly home.

21 From that day on, Madame Charity tried not to raise her voice in anger. Sometimes she got angry, but she kept it to herself. And Zel the gentle donkey was happy at last.

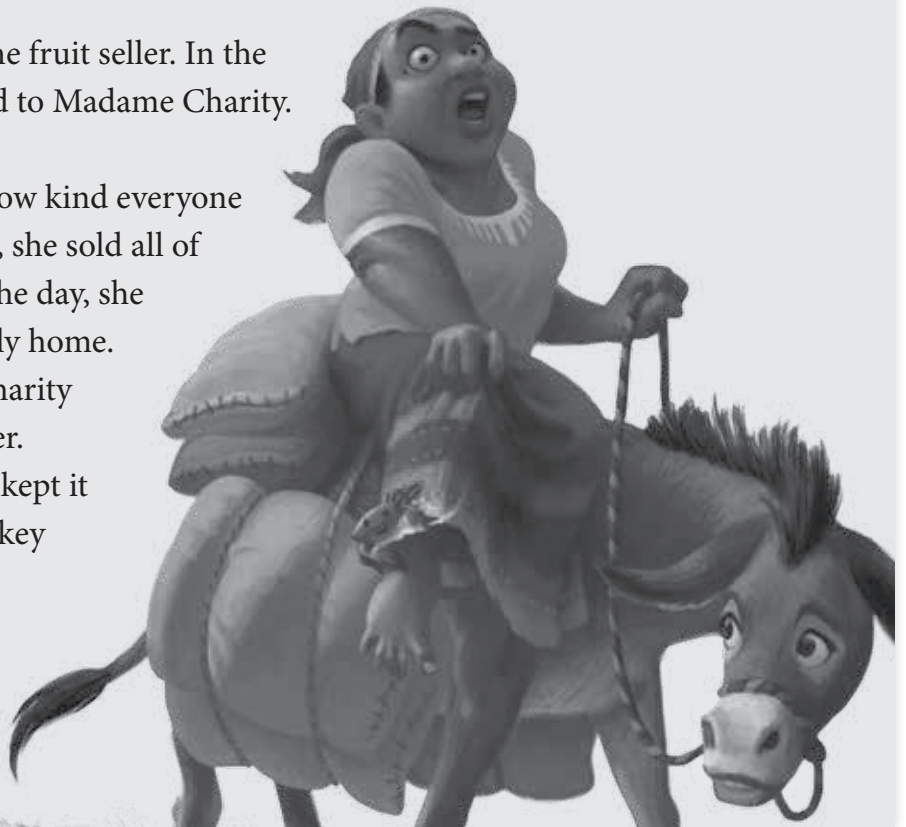

Think Use what you learned from reading the selection to respond to these questions.

- 1** Which detail in the first part of the story explains why Madame Charity is cruel to Zel?
- A** Zel does not walk to the market as fast as she is able to.
 - B** Madame Charity is always angry and mean.
 - C** Madame Charity does not have enough sugar and rice to sell.
 - D** Everyone in town loves Zel because she is pleasant and kind.

- 2** Describe how Touloulou helps Zel.

- 3** This question has two parts. First, answer Part A. Then answer Part B.

Part A

What is the central message of this story?

- A** Honesty is the best policy.
- B** Kindness gets better results than anger.
- C** Things are not always as they appear.
- D** Beware of strangers.

Part B

Which sentence from the story is **most** important to the central message of the story?

- A** "Madame Charity, you should get up earlier."
- B** "Then she got angry and yelled at Zel. . . ."
- C** "From that day on, Madame Charity tried not to raise her voice in anger."
- D** "Today he felt sorry for her."

- 4** What is the meaning of the word *market* as it is used in this sentence from the story?

Every Saturday, Madame Charity sold sugar and rice at a market.

- A** a store where food and spices are bought
- B** a place where people buy and sell things
- C** a street fair where people gather
- D** a bank where money is exchanged



Write A central message of “Zel, the Gentle Donkey” is that being kind to others can cause good things to happen. Explain how the actions of the characters in the story show this central message.

- 5 Plan Your Response** Make a list of things from the story that tell about the kindness of some of the characters.

- 6 Write an Extended Response** Review the central message of “Zel, the Gentle Donkey.” Explain how the characters in the story help deliver this message. Use details from the story to support your answer.

Tools for Instruction

Determine Message, Lesson, or Moral

An important part of reading development is recognizing that a story is likely to convey a message or lesson, and learning how to read closely to determine it. Some stories teach a lesson explicitly, while other stories have lessons that are implied. Determining an implied lesson can be hard for readers because it requires them to go beyond retelling events to more sophisticated skills, such as analyzing details and making inferences. When teaching students how to determine the message, lesson, or moral of a story, it is helpful to use stories with stated and unstated morals so that students can gain confidence in finding the message as they progress from concrete to abstract thinking.

Three Ways to Teach

Analyze a Stated Message, Lesson, or Moral 20–30 minutes

Scaffold students' ability to determine the message in any story by analyzing stories with stated messages. Help them think about the way the author uses details and shapes events in order to teach a lesson.

- Choose a brief fable—a story with an explicitly stated moral—and read it aloud. Then model for students how to identify the moral and think about how the details in the story point to the lesson readers should learn. The following example is based on Aesop's "The Boy Who Cried Wolf."

In a fable, we are told the story's lesson at the very end. The lesson is called a moral. So what is the moral of this story? The last line says, "Nobody believes a liar, even when he is telling the truth!" Let's think about how the details in the story make this lesson clear. We read that the boy was bored and that he lied about seeing the wolf to amuse himself. We also read that the villagers were very upset that they had been tricked, especially the second time. When the boy really sees a wolf, nobody believes him. These details match the moral stated at the end, that "nobody believes a liar." No one in the village trusted the boy because of his lies.

- Distribute and display **Message, Lesson, or Moral Chart**, and work together to record details from the story on the chart. Explain to students that the chart is a useful way for them to see how details are connected to one moral or big idea.
- Then provide a selection of other fables for students to practice with independently. Have students work in pairs to read a fable and identify its moral, stated at the end. Have them use the message, lesson, or moral chart to connect story details to the overall lesson. Remind them to think carefully about characters' words and actions, as well as what happens and why.
- Invite pairs to share their work with the class.

Determine an Unstated Message, Lesson, or Moral 10–15 minutes

As students begin to read chapter books, teach them how to think about details and events in order to figure out the lesson the author wants readers to learn.

Choose a section from a current story, or reflect on an entire story that students have recently finished reading. Say, *The author uses the key events in the story to show readers what can happen as a result of certain choices. The author expects us, as readers, to think about what we can learn from these events.* Then model how to determine an unstated message by asking questions about what you read. The following example is based on *Charlotte's Web*, by E. B. White.

What decision did Charlotte make? (to write a message in her web)

Why did she make it? (to help save Wilbur from slaughter)

What happened because of that decision? (Wilbur was chosen for the fair.)

What did everyone learn? (Big or small, we can use what we have to help others.)

Point out that the answer to the last question is the author's message. Help students think about how this message applies to other stories they have read, and to their own lives.

Convey a Message, Lesson, or Moral 30–45 minutes

Connect to Writing Ask students to think of a lesson they would want to teach a younger sibling or friend. You might suggest lessons about telling the truth or being nice to one another. Tell them to write their lesson at the top of a piece of lined paper. Then have them each craft a brief story that effectively conveys their lesson. If students need additional support, you might organize them in pairs or small groups to brainstorm. Invite volunteers to share their stories with the class, and discuss the lessons in each story.

Check for Understanding

If you observe...	Then try...
difficulty identifying an unstated moral	first checking comprehension by asking them to retell or summarize the story in their own words. Then help them identify the moral using guiding questions such as these: <i>What was the main character's problem?</i> <i>How did that problem get solved?</i> <i>Did you think the character did the right or wrong thing?</i> <i>What did we learn from this example?</i>

Name _____

Message, Lesson, or Moral Chart

<p>Details</p>	<p>Details</p>	<p>Details</p>
<p>Message, Lesson, or Moral</p>		

The diagram consists of three rectangular boxes labeled 'Details' arranged horizontally. Arrows from the bottom center of each 'Details' box point towards a larger rectangular box at the bottom labeled 'Message, Lesson, or Moral'.

Lesson 33

Words for Time and Space

 **Introduction** How can you help make your writing clear for readers? One way is to use words and phrases that explain when and where actions or events take place.

- Words and phrases that tell *when* show the time events happen or the order in which they happen. *First, second, next, often, at noon,* and *in the morning* are some words and phrases that tell when events happen.

When Plan your garden in the winter.

 First, decide what to grow.

- Words and phrases that tell *where* show the position or direction of something. *Down, around, under, close to,* and *on the right* are some words and phrases that tell where.

Where Vegetables grow best in sunny areas.

 Some flowers can grow under trees or climb up walls.

 **Guided Practice**

Complete each sentence. If the parentheses () say *when*, add a word or phrase that tells *when*. If they say *where*, add a word or phrase that tells *where*.

HINT Think about what happens when you plant and care for a garden. What words and phrases that tell *when* or *where* will make the steps clear?

- 1 _____, get a shovel and loosen the soil. (when)
- 2 Plant your seeds, and be sure to water them _____
 _____ . (when)
- 3 The roots of the tiny seedlings will grow _____
 _____ . (where)
- 4 The stems and leaves will grow _____
 _____ . (where)
- 5 Don't forget to weed your garden _____
 _____ . (when)



Independent Practice

For numbers 1–5, complete each sentence by choosing the word or phrase that tells *when* or *where*.

- 1** If you have packets of seeds, _____ read the directions.
- A** slowly
 - B** first
 - C** carefully
 - D** you must
- 2** It's a good idea to plant _____.
- A** vegetables
 - B** many seeds
 - C** in the morning
 - D** with a friend
- 3** You can grow corn, squash, and beans _____.
- A** near one another
 - B** if you want
 - C** for food
 - D** for your family
- 4** Some seeds sprout _____.
- A** in just a few days
 - B** with little water
 - C** but others do not
 - D** without much trouble
- 5** Once your vegetables grow, you can share them _____.
- A** with neighbors
 - B** easily
 - C** too
 - D** at school

Lesson 7

Recounting Stories



Learning Target



Retell or recount stories from around the world by telling key events in the order in which they happened.

- **Read** When you **recount** a story, you are retelling the story in your own words. Be sure that you include the key details and **events** that happened in the beginning, middle, and end. Tell the events in the **sequence**, or order, in which they happened.

Read this story. Think about what happens at the beginning, middle, and end. Then reread the story. What are the most important details?



A Bundle of Sticks

Long ago, a mother had three children who were always arguing. "Your arguing sounds worse than the clucking of all the hens in the world," their mother told them. She wanted them to stop!

One day she got an idea. She gathered the children around her. Then she took a stick and broke it. "See how easy it is to break one stick?" she asked. Then she tied three sticks together. She asked each child to try to break the sticks. None of the children could break the bundle.

The mother told the children, "We're just like the sticks. When we don't stay together, our family is weak. When we stay together, nothing can break us apart."

The children understood! From that day forward, they didn't argue (as much).

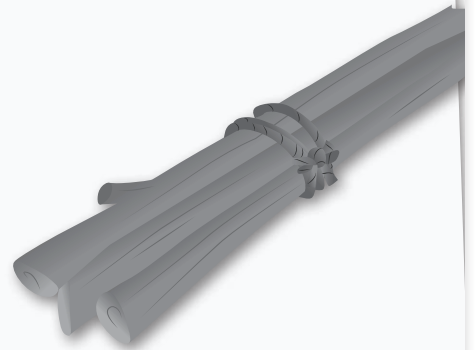

► **Think** The chart below will help you to organize the most important details of a story. Think about what happened in the beginning, middle, and end of the story. Then add those details to the chart.

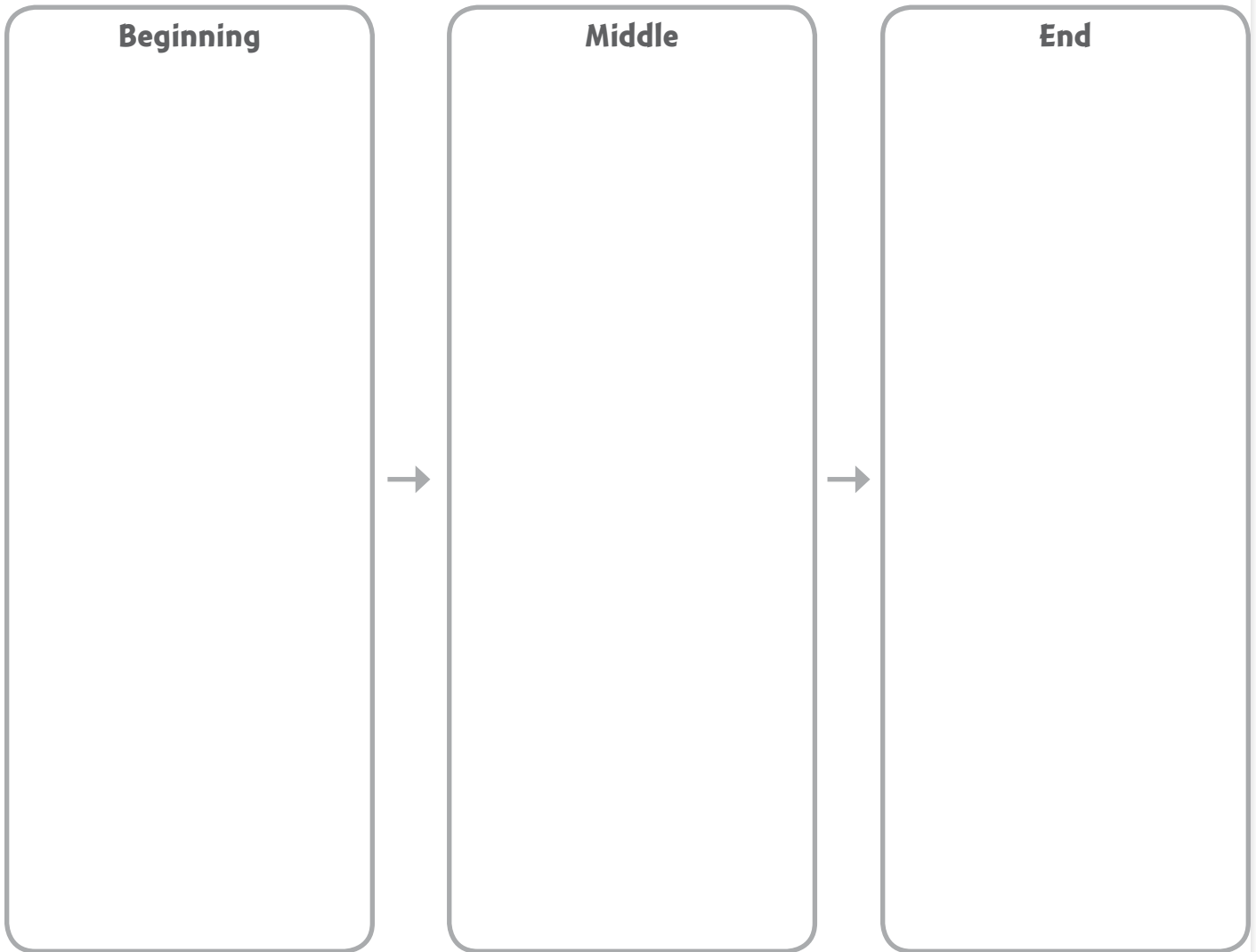

► **Talk** Using the key details in your chart, retell the story to your partner.



Academic Talk

Use these words to talk about the text.

- **recount**
- **sequence**
- **character**
- **setting**
- **events**

Brother and Sister

a folktale from Korea

- 1 Long ago, a brother and sister grew rice to sell. Through the long summer, they worked together to care for the rice paddies. In the fall, they harvested all the rice and put the rice into bags. Each got the same number of bags.
- 2 After one harvest, the brother announced he was soon to be married. The sister knew her brother would need money to buy a new house for his bride. She didn't feel the rice was divided fairly, so that night, she took an extra bag of rice to her brother's house in secret.
- 3 The brother, too, felt the rice was not divided fairly. His sister had a large family. She would need more rice. So that night, the brother took an extra bag to his sister's house in secret.
- 4 The next day, the brother and sister counted their rice bags. Strange! Both had the same number as before. So that night, when the moon was full, they made another attempt. In the moonlight, the brother and sister each saw the other carrying a bag of rice! They laughed. The mystery was solved.



Close Reader Habits

Underline the sentences that tell the key events.

Explore

How do you choose which details to include when you recount a story?



To decide whether a detail is important, think about whether the story makes sense without it.

Think

- 1 Recount the folktale "Brother and Sister" by adding key details to the chart below.

Beginning	<i>A brother and sister grow and sell rice. They each get the same number of bags of rice.</i>
Middle	<i>Sister</i> <i>Brother</i>
End	

Talk

- 2 Using the details from your chart, take turns retelling the story with your partner.



Write

- 3 **Short Response** Which details from the chart do you think are most important? List them and tell why you chose them. Use the space provided on page 37 to write your answer.

HINT What details would you need to help a friend understand what happens in the story?

HOW THE BAT GOT WINGS

A CHEROKEE NATION TALE

- 1 A long time ago, the bat was a tiny mammal. It had no wings. One day, the mammals and birds decided to play a game. The birds played on one team, and the mammals played on the other team.
- 2 The bat wanted to play with the mammals, but the mammals laughed at her size. “You are too small,” they said.
- 3 So the bat asked to play with the birds. The birds said, “You don’t have wings, but we can make you some out of a drum.” The birds stretched the skin of a drum into wings.
- 4 The birds put the wings on the bat and said, “Flap your wings.” The bat jumped off a tree and flapped her wings, but she didn’t fly in a straight line like the birds. Instead, she flew every which way in a crazy, zigzag pattern.
- 5 The birds let the bat play on their team. Just as she had done before, the bat flew in a crazy, zigzag pattern. The mammals on the other team could not catch the bat. The bat scored the winning points for the birds.
- 6 When the game was over, the mammals said, “Who is that superstar on your team?”
- 7 The birds said, “It is the bat. We gave her wings.”
- 8 The mammals did not know what to say. After all, they had refused to let the tiny bat play on their team. The mammals had learned their lesson. From that day on, they let any animal of any size play on their team.



Close Reader Habits

Which details would you include to recount the story? **Underline** the most important ones.



When you get ready to recount a story, choose the most important details.

Think

1 Number the items to show the order of some events in the story.

___ The bat flies in a crazy, zigzag pattern.

___ The birds make wings for the bat.

___ The mammals do not let the bat play on their team.

2 Why do the birds win the game?

A The mammals cannot follow the bat's movements.

B The mammals are surprised to see the bat on the team.

C The mammals refuse to play against a bat.

D The birds fly in a crazy, zigzag pattern.

Talk

3 Using key details from the text, talk to your partner about how the bat's way of flying helps the birds win.

Write

4 **Short Response** In your own words, recount what happens when the bat plays the game with the birds. Be sure to include the most important details from the story. Use the space provided on page 40 to write your answer.

HINT Review the game in paragraphs 5 to 8.

WORDS TO KNOW

As you read, look inside, around, and beyond these words to figure out what they mean.

- **fuss**
- **disbelief**

True or False

a folktale from Myanmar (Burma)

- 1 There once were three poor brothers who loved to tell tall tales. They traveled throughout the countryside telling wild stories. They always claimed that their tales were true, but no one ever believed them.
- 2 One day, the three brothers met a rich traveler. The man was dressed in fine clothes and wore shining jewels. The brothers wanted his things. “Let’s ask him to play a game. Each of the four of us will tell a tale of a past adventure. The rule is that if anyone doubts the truth of another’s story, he must become that person’s servant. The man will never believe our stories. Getting him to doubt our stories will be like rolling off a log. He will have to become our servant.”
- 3 The others liked this plan. They did not want a servant. But they wanted the man’s fine things. The man agreed to the game.
- 4 The first brother told a story of how he had climbed a tree and could not get down. So he ran to a nearby cottage and borrowed a rope.
- 5 The second brother told of jumping into the stomach of a tiger who wanted to eat him. “I made such a fuss that the tiger spit me out,” he said.

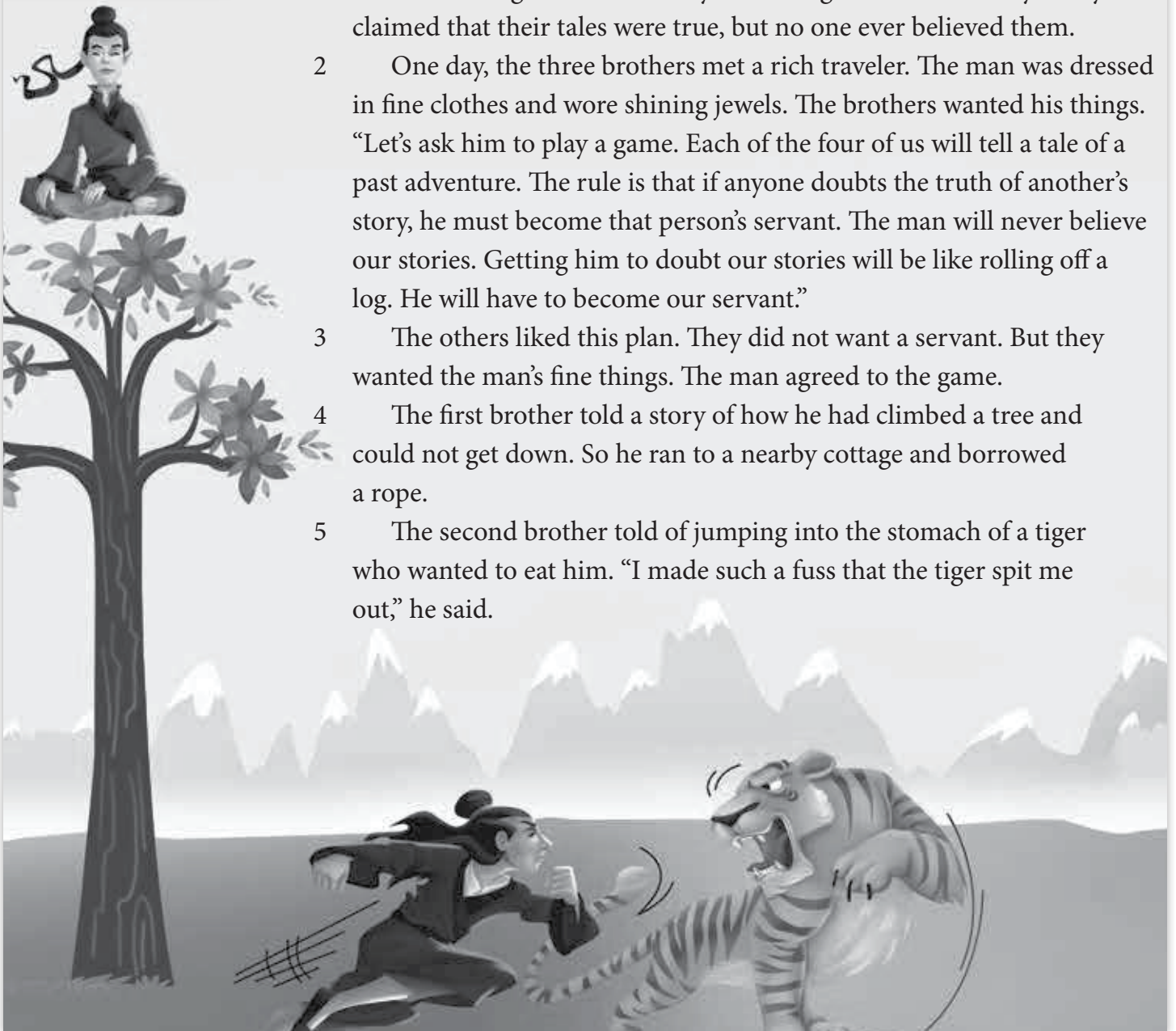

6 The third told of helping the village fishermen. He said he turned into a fish and jumped into the river. There, he turned back into a man and killed the big fish that were eating all the little fish.

7 The rich man listened to the three tales without saying one word of disbelief. Then he told his story. He said he was searching for three servants who had run away from him.

8 “You three must be the ones I am looking for,” he said.

9 The brothers looked at him with alarm. If they doubted him, they must become his servants. That was their rule. But if they said his story was true, they would have to become his servants too!

10 They said nothing.

11 Finally, the man said he would let them go if they promised never to tell tall tales again.

12 The brothers agreed, and they kept their promise.



► **Think** Use what you learned from reading the selection to respond to these questions.

1 Number the items to show the order of some events in the story.

____ Each brother told his make-believe story.

____ Three brothers talked a rich traveler into playing a game.

____ The rich man made them promise not to tell tall tales.

____ The rich man told them a story.

____ The rich man did not question the brothers' stories.

____ The brothers realized they were trapped.

2 This question has two parts. First, answer Part A. Then answer Part B.

Part A

Why did the three brothers want to play a game with the traveler?

- A** They wanted to see if he would believe their tall tales.
- B** They wanted to trick him so they could have what he owned.
- C** They disliked people who had more money than they did.
- D** They were once the rich traveler's servants.

Part B

Write a sentence from paragraph 2 that supports the answer you chose for Part A.

- 3** Which is the **best** recounting of the third brother's story?
- A** He plays a trick on the fishermen. He pretends to be a big fish catching small ones.
 - B** He gets away from the fishermen by swimming in the river like a fish.
 - C** He helps the fishermen. He turns himself into a fish and then back into a person to kill a big fish.
 - D** He becomes a fish so that he can help the fishermen chase fish into their nets.
- 4** Which is the **best** description of the brothers' problem at the end of the folktale?
- A** The brothers think the rich man's story is the best of all the stories they have heard.
 - B** The rich man believes that the brothers are the runaway servants he is looking for.
 - C** The brothers promise never to tell tall tales again as they know they should not be doing that.
 - D** No matter how the brothers answer the rich man, they will have to become his servants.

5 Which **two** details could you leave out when recounting this story?

- A The brothers tell their tales throughout the countryside.
- B The brothers ask a rich traveler to play a game.
- C A tiger spit one brother out after eating him.
- D The rich man said nothing about the brothers' stories.
- E The rich man told a story about missing servants.
- F The brothers agreed not to tell any more tall tales.

6 Reread these sentences from paragraph 2.

The man will never believe our stories. Getting him to doubt our stories will be like rolling off a log.

What does the word *doubt* mean in this context?

- A dislike
- B understand
- C mistrust
- D enjoy



Write

- 7 Short Response** Use your own words to recount the folktale. Be sure to write about the events in the sequence that they happen in the story.



Learning Target

Explain why recounting the events in a story will help you understand it.

Reading

Read the passage. Then answer the questions that follow.

Following the Stars

by Krista O'Connell

1 “Wait up!” Robert said, hurrying along the forest path.

2 Jake stopped for a moment, letting his eyes adjust to the semi-darkness around him. Thankfully, there was plenty of moonlight. “You’re too slow,” he called. “Hurry up!”

3 “No, you’re too fast,” Robert replied with a smile. “Slow down!” This was a regular joke between the two boys. They had been friends for as long as either could remember. And they were as different as they could be.

4 But this evening, Jake wasn’t in the mood for joking. They were completing the final test for their summer nature camp. They had to find the North Star and follow it until they came to an open field. The counselors would be waiting for them beside a toasty warm campfire. Each of the boys wore a whistle. If either blew the whistle, it would be a signal they were lost.

5 Robert was calm. He had spent lots of time hiking, even at night. But his friend was in a rush and getting worried. This was Jake’s first time out of the city. He wanted to get to the safety of the campfire as quickly as he could. “I’m going to blow my whistle. What were they thinking letting us wander around the woods alone at night?” Jake griped, standing close to Robert.

6 “Take it easy!” Robert patted Jake on the back. “We just have to use what we learned. Let’s break it down into steps. We can do this!”

7 Jake took a deep breath. “Okay, okay. I guess we’re not in any danger yet. First things first, find the Big Dipper,” Jake said. The two boys stood still and looked up. For a moment, they forgot about their task and stood in awe of the sight. Away from the lights of the city, the black sky was bursting with stars.

8 But soon the boys remembered their job and began searching for the stars that formed the Big Dipper. “There!” Robert shouted, pointing his finger at a patch of stars.

9 Jake looked up to where Robert was pointing. He smiled when he saw a familiar shape among the tangle of stars. “Okay, let’s go,” Jake said, and started walking quickly away from their spot in the forest.

10 Robert grabbed his shoulder. “Wait, let’s take our time. We want to be sure we get it right,” Robert said, shaking his head. Jake was always jumping into things too fast. “What’s the next step?”

11 Jake sighed. “I guess you’re right. Okay, the next thing is to find the two stars at the end of the Big Dipper, on the side of the cup across from the handle,” Robert said.



12 “There they are,” Jake said. He pointed to the picture, and then up into the sky.

13 “Now, we just have to imagine a line connecting the stars. The end of the line should point to the North Star,” Robert recalled. They soon saw the star that shone brighter than many of the others around it. They began walking toward it, hoping their decision was the right one.

14 They didn’t have to travel far. Within minutes, they could see the warm glow of a campfire through the trees. When they proceeded into the clearing, everyone clapped and cheered. “Told you we wouldn’t need the whistle,” Robert told Jake with a grin and a friendly whack on the back.

15 “I guess you were right...for once,” Jake said, smiling. He was proud that he hadn’t given up and blown the whistle. As the friends walked toward the fire, they knew they would remember how those stars had helped them find their way, long after they returned home.

1 Which sentence from “Following the Stars” tells what Jake and Robert must do for their final test at camp?

- A** “Jake stopped for a moment, letting his eyes adjust to the semi-darkness around him.”
- B** “They were completing the final test for their summer nature camp.”
- C** “They had to find the North Star and follow it until they came to an open field.”
- D** “Within minutes, they could see the warm glow of a campfire through the trees.”

2 Why does Robert grab Jake’s shoulder in paragraph 10 of “Following the Stars”?

- A** to stop Jake from walking into a clump of poison ivy
- B** to get Jake to slow down and carefully find the North Star
- C** to ask Jake to blow the whistle to let everyone know they are lost
- D** to make Jake leave him alone in the woods

- 3** The following question has two parts. First, answer part A. Then, answer part B.

Part A

Read this sentence from the story.

Away from the lights of the city, the black sky was bursting with stars.

Which of the following best describes the meaning of the word “bursting” as it is used in this sentence?

- A** dimly lit
- B** blowing up
- C** flying apart
- D** completely filled

Part B

Which sentence from the story **best** supports the answer to part A?

- A** “Jake stopped for a moment, letting his eyes adjust to the semi-darkness around him.”
- B** “He had spent lots of time hiking, even at night.”
- C** “They soon saw the star that shone brighter than many of the others around it.”
- D** “He pointed to the picture, and then up into the sky.”

- 4** Which sentence **best** begins a retelling of “Following the Stars”?
- A** Jake and Robert are taking their final test at summer nature camp.
 - B** Jake and Robert find the Big Dipper and the North Star.
 - C** Jake and Robert proudly walk into the clearing following the stars.
 - D** Robert is calm, but Jake is worried about passing the final test.
- 5** Select the **two** sentences that **best** tell how the picture in “Following the Stars” helps readers better understand the story.
- A** It shows that Jake is walking much faster than Robert.
 - B** It shows how far the boys had to walk to find the camp.
 - C** It shows what Jake and Robert saw in the sky that night.
 - D** It shows how Jake and Robert feel during the test.
 - E** It shows that Robert is more at ease in the woods than Jake.
 - F** It shows how alone Jake and Robert are out in the dark woods.

Lesson 20

Possessive Nouns

 **Introduction** Some nouns show that a person or animal owns something. A noun that shows ownership is called a **possessive noun**. For example, *the girl's hat* means that the girl owns or has the hat. *The tiger's fur* means that the fur belongs to the tiger.

- To form the possessive of a singular noun, add an **apostrophe (')** and then an **-s**.

seller + 's The ticket seller's booth is at the front of the zoo.

- To form the possessive of a plural noun, add an apostrophe (') *after* the **-s**.

lions + ' The lions' area is near the back of the zoo.

Guided Practice

Write the possessive form of the noun in parentheses () to complete each phrase.

HINT How can you tell if the possessive noun should be singular or plural? Look at the ending of the noun in (). Also look for clue words, such as *a*, *one*, *several*, and *few*.

- 1 a _____ key (zookeeper)
- 2 several _____ ears (bunnies)
- 3 one _____ flippers (penguin)
- 4 a few _____ tails (foxes)
- 5 three _____ brooms (cleaners)
- 6 a _____ tickets (guest)
- 7 some _____ nests (cranes)
- 8 an _____ egg (emu)

 **Independent Practice**

For numbers 1–5, choose the correct way to write each underlined noun.

1 Several workers pails had food for the animals.

- A** worker's'
- B** workers
- C** worker's
- D** workers'

2 The workers put bottles in a few babies mouths.

- A** babies'
- B** babies's'
- C** babies
- D** babies's

3 The zookeeper pointed out three ostriches strong legs.

- A** ostriches's
- B** ostriches
- C** ostriches'
- D** ostriches's

4 There was a big spray of water from an elephants trunk.

- A** elephants
- B** elephant's
- C** elephants's
- D** elephants'

5 We loved seeing one peacocks colorful feathers.

- A** peacocks'
- B** peacocks
- C** peacock's
- D** peacocks's

Writing and Research

This is a rough draft of a story. It has some mistakes. Read the story. Then answer the questions that follow.

Baby Bird

One day Alec and Molly were walking through the park. Suddenly, they saw something move in the grass. It was a baby bird! It was small and round. It had fluffy brown feathers. But its mother was nowhere in sight.

Alec said “The baby bird must be lost.”

The children walked closer. The baby bird tried to run away. They could see the scared feeling in its eyes.

Alec and Molly didn’t know what to do.

“Let’s pick it up so a cat won’t get it, said Alec.

But Molly said that would scare the baby bird even more. Let’s hide it under a box” she suggested.

Alec thought that was a bad idea. The mother bird would never find it under a box.

Finally the children decided to just watch and wait. “If a cat comes, we will chase it away,” they agreed.

So the children crawled behind a bush and watch quietly.

A long time went by. Nothing happened. No cats appeared, but the mother did not either. Molly and Alec grew more and more worried.

All of a sudden, they heard a bird chirping loudly. The baby bird chirped back. A yellow bird flew down. It was the baby birds mother! She gave her baby a bug that was in her beak. The baby bird ate it right up and chirped for more.

“Hooray!” Molly and Alec shouted. The baby bird wasn’t lost after all!

23 Read this sentence from the story.

So the children crawled behind a bush and watch quietly.

Which of the following is the correct tense for the verb “watch” in this sentence?

- A** watched
- B** watches
- C** will watch
- D** correct as is

24 Which sentence from the story uses commas and quotation marks correctly?

- A** Alec said "The baby bird must be lost."
- B** "Let's pick it up so a cat won't get it, said Alec.
- C** Let's hide it under a box" she suggested.
- D** "If a cat comes, we will chase it away," they agreed.

25 Read the sentence from the story.

It was the baby birds mother!

Circle the word in the sentence that needs an apostrophe to show possession.
Then write the sentence correctly on the line below.

26 To change a word ending in the letter *y* from singular to plural, remove the *y* and add *-ies*. How would you spell the plural of "baby"?

- A** babys
- B** babies
- C** babyies
- D** baies

Reading Discourse Cards

UNDERSTANDING LITERATURE 

How does a character change in the story?

First, the character _____.
Then, the character _____.

Ready | Reading ©Curriculum Associates, LLC 5

UNDERSTANDING LITERATURE 

If the story were told by a different character, which details might be different?

Ready | Reading ©Curriculum Associates, LLC 11

UNDERSTANDING LITERATURE 

How do the illustrations help you understand the characters, setting, or events in the story?

Ready | Reading ©Curriculum Associates, LLC 14

UNDERSTANDING INFORMATIONAL TEXTS 

What is the main topic of this text?
How do you know?

Ready | Reading ©Curriculum Associates, LLC 16

KNOWLEDGE BUILDING 

What does this text help you understand?

Now I know _____.

Ready | Reading ©Curriculum Associates, LLC 32

KNOWLEDGE BUILDING 

What does this part of the text make you want to learn more about?

The text makes me want to know _____.

Ready | Reading ©Curriculum Associates, LLC 33

KNOWLEDGE BUILDING 

What do you already know about this topic?
Where have you learned about this topic?

I already know _____
from _____.

Ready | Reading ©Curriculum Associates, LLC 37

KNOWLEDGE BUILDING 

What were you surprised to learn from the text?

Ready | Reading ©Curriculum Associates, LLC 40

ACADEMIC TALK 

I'm curious about _____.

Ready | Reading ©Curriculum Associates, LLC 70

ACADEMIC TALK 

Can you tell me more about _____?

Ready | Reading ©Curriculum Associates, LLC 77

Tarjetas de discusión

TEXTOS LITERARIOS 

¿Cómo cambia un personaje a lo largo de la historia?

Primero, el personaje _____.
Luego, el personaje _____.

Ready | Reading ©Curriculum Associates, LLC 5

TEXTOS LITERARIOS 

Si la historia la contara un personaje diferente, ¿qué detalles podrían ser distintos?

Ready | Reading ©Curriculum Associates, LLC 11

TEXTOS LITERARIOS 

¿Cómo te ayudan las ilustraciones a comprender los personajes, el escenario o los sucesos de la historia?

Ready | Reading ©Curriculum Associates, LLC 14

TEXTOS INFORMATIVOS 

¿Cuál es el tema principal de este texto?
¿Cómo lo sabes?

Ready | Reading ©Curriculum Associates, LLC 16

ASIMILAR CONOCIMIENTOS 

¿Qué te ayuda a entender este texto?

Ahora sé _____.

Ready | Reading ©Curriculum Associates, LLC 32

ASIMILAR CONOCIMIENTOS 

¿Sobre qué te anima a aprender más esta parte del texto?

El texto hace que quiera saber _____.

Ready | Reading ©Curriculum Associates, LLC 33

ASIMILAR CONOCIMIENTOS 

¿Qué sabes ya sobre este tema?
¿Dónde has aprendido sobre este tema?

Ya sé _____
Lo aprendí _____.

Ready | Reading ©Curriculum Associates, LLC 37

ASIMILAR CONOCIMIENTOS 

¿Qué aprendiste en el texto que te haya sorprendido?

Ready | Reading ©Curriculum Associates, LLC 40

LENGUAJE ACADÉMICO 

Siento curiosidad por _____.

Ready | Reading ©Curriculum Associates, LLC 70

LENGUAJE ACADÉMICO 

¿Puedes decirme algo más sobre _____?

Ready | Reading ©Curriculum Associates, LLC 77